

# TECHNICAL DATASHEET



## EF COUPLER

00 Update - 09/2015

### TECHNICAL DATA

Article No	001 117 2160 0075
d (mm)	75
D (mm)	94
Z (mm)	110
m (mm)	24
Weight (Kg)	0,22
Box Quantity (pcs)	16
Box Dimension (cm)	41x41x15

### INJECTION MOULDED

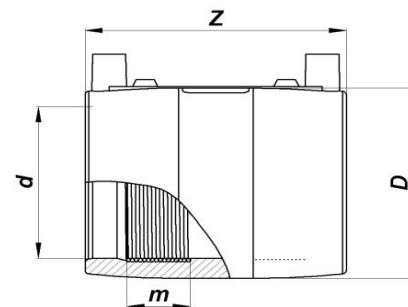

### IDENTIFICATION OF PRODUCT

D(mm)	75
SDR	11
RAW MATERIAL	PE 100
PRESSURE CLASS	16 Bar Water 10 Bar Gas
TRADEMARK	NTG
EXECUTION	Injection Moulded
STANDARD	EN 12201-3 EN 1555-3 AS / NZS 4129
SPECIFICATION	Suitable for SDR11....17 pipe Removable center stopper 4 mm pin connectors

### EF SPECIFICATION

WELDING VOLTAGE	40 V
RESISTANCE	1.1 $\Omega$
WELDING TIME	65 Sec
COOLING TIME	15 Min
WINDING TYPE	Monofilar

WELDING BARCODE



442007320753401106065118

Tolerance on diameters and thickness according to the standards. The other dimensions are specialized. Tolerance  $\pm 5\%$ . NTG PLASTIK reserves all the right to change any information without giving prior notice. The production, distribution and utilization of this document without explicit authorization is prohibited.