

TECHNICAL DATASHEET



EF COUPLER

00 Update - 09/2015

TECHNICAL DATA

Article No	001 117 2160 0180
d (mm)	180
D (mm)	217
Z (mm)	184
m (mm)	48
Weight (Kg)	1,91
Box Quantity (pcs)	6
Box Dimension (cm)	55x60x21

INJECTION MOULDED

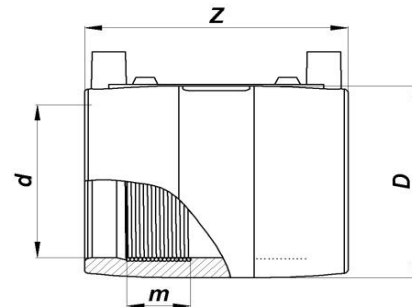

IDENTIFICATION OF PRODUCT

D(mm)	180
SDR	11
RAW MATERIAL	PE 100
PRESSURE CLASS	16 Bar Water 10 Bar Gas
TRADEMARK	NTG
EXECUTION	Injection Moulded
STANDARD	EN 12201-3 EN 1555-3 AS / NZS 4129
SPECIFICATION	Suitable for SDR11....17 pipe Removable center stopper 4 mm pin connectors

EF SPECIFICATION

WELDING VOLTAGE	40 V
RESISTANCE	0.90 Ω
WELDING TIME	530 Sec
COOLING TIME	20 Min
WINDING TYPE	Monofilar
WELDING BARCODE	

442007331803400906530116

Tolerance on diameters and thickness according to the standards. The other dimensions are specialized. Tolerance $\pm 5\%$. NTG PLASTIK reserves all the right to change any information without giving prior notice. The production, distribution and utilization of this document without explicit authorization is prohibited.